



## LOW POWER DUAL OPERATIONAL AMPLIFIER LM358

### DESCRIPTION

The LM358 consists of two independent, high gain, internally frequency compensated operational amplifiers which were designed specifically to operate from a single power supply over a wide range of voltages. Operation from split power supplies is also possible and the low power supply current drain is independent of the magnitude of the power supply voltage.

Application areas include transducer amplifiers, DIP-8  
DC gain blocks and all the conventional op amp circuits which now can be more easily implemented in single power supply systems. For example, the LM358 can be directly operated off of the standard +5V power supply voltage which is used in digital systems and will easily provide the required interface electronics without requiring the additional  $\pm 15V$  power supplies.

Outline Drawing

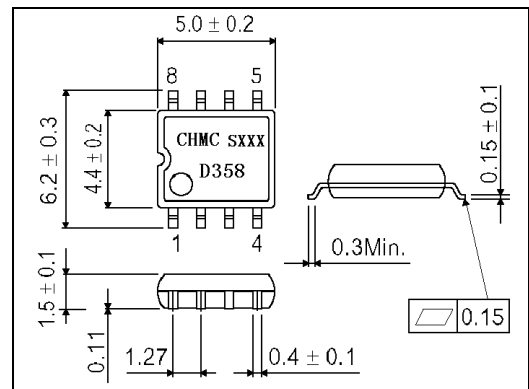
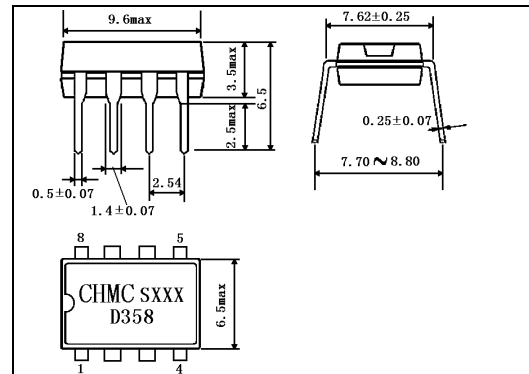

SOP-8

### UNIQUE CHARACTERISTICS

- In the linear mode the input common-mode voltage range includes ground and the output voltage can also swing to ground, even though operated from only a single power supply voltage.
- The unity gain cross frequency is temperature compensated.
- The input bias current is also temperature compensated.

### ADVANTAGES

- Two internally compensated op amps.
- Eliminates need for dual supplies.
- Allows direct sensing near GND and  $V_{OUT}$  also goes to GND.
- Compatible with all forms of logic.
- Power drain suitable for battery operation.

## FEATURES

- Internally frequency compensated for unity gain
- Large dc voltage gain: 100 dB
- Wide bandwidth (unity gain): 1 MHz (temperature compensated)
- Wide power supply range:
  - Single supply: 3V to 32V
  - or dual supplies:  $\pm 1.5V$  to  $\pm 16V$
- Very low supply current drain (500  $\mu A$ )—essentially independent of supply voltage.
- Low input offset voltage: 2 mV
- Input common-mode voltage range includes ground
- Differential input voltage range equal to the power supply voltage
- Large output voltage swing: 0V to  $V^+ - 1.5V$

## BLOCK DIAGRAM AND PIN CONNECTION

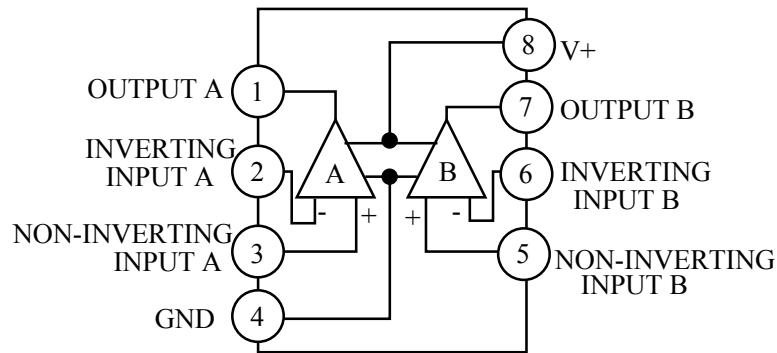

## ABSOLUTE MAXIMUM RATINGS (Ta=25°C)

Characteristic		Value	Unit
Supply Voltage, $V^+$		32 或 $\pm 16$	V
Differential Input Voltage		32	V
Input Voltage		-0.3~32	V
Power Dissipation (Note 1)	DIP Package	550	mW
	SOP Package	530	
Output Short-Circuit to GND ( One Amplifier ) ( Note 2 ) ( $V^+ \leq 15V$ 、 $T_a = 25^\circ C$ )		Continuous	
Input Current ( $V_{IN} < -0.3V$ ) ( Note 3 )		50	mA
Operating Temperature Range		-20~+85	°C
Storage Temperature Range		-65~150	°C

**ELECTRICAL CHARACTERISTICS** (Unless otherwise specified:  $V^+=5.0V$ )

Parameter		Test Conditions	Min.	Typ.	Max.	Unit
Input Offset Voltage		$T_a=25^\circ C$ (Note 5)		2	5	mV
Input Bias Current		$T_a=25^\circ C$ , $I_{IN(+)}$ or $I_{IN(-)}$ , $V_{CM}=0V$ (Note 6)		45	150	nA
Input Offset Current		$T_a=25^\circ C$ , $I_{IN(+)} - I_{IN(-)}$ , $V_{CM}=0V$		3	30	nA
Input Common-Mode Voltage Range		$T_a=25^\circ C$ , $V^+=30V$ (Note 7)	0		$V^+ - 1.5$	V
Supply Current		Over Full Temperature Range, $R_L=\infty$ on all Op Amps	$V^+=30V$	1	2	mA
			$V^+=5V$	0.5	1.2	
Large Signal Voltage Gain		$V^+=15V$ , $T_a=25^\circ C$ , $R_L \geq 2k\Omega$ (For $V_o=1\sim 11V$ )	50	100		V/mV
Common-Mode Rejection Ratio		DC, $T_a=25^\circ C$ , $V_{CM}=0\sim V^+ - 1.5V$	70	90		dB
Power Supply Rejection Ratio		DC, $T_a=25^\circ C$ , $V^+=5\sim 30V$	75	100		dB
Amplifier-to-Amplifier Coupling		$T_a=25^\circ C$ , $f=1\sim 20kHz$ (Input Referred) (Note 8)		-120		dB
Output Current	Source	$V_{IN(+)}=1V$ , $V_{IN(-)}=0V$ , $V^+=15V$ , $V_o=2V$ , $T_a=25^\circ C$	20	40		mA
	Sink	$V_{IN(-)}=1V$ , $V_{IN(+)}=0V$ , $V^+=15V$ , $V_o=2V$ , $T_a=25^\circ C$	10	20		mA
		$V_{IN(-)}=1V$ , $V_{IN(+)}=0V$ , $V^+=15V$ , $V_o=200mV$ , $T_a=25^\circ C$	12	50		$\mu A$
Short Circuit to Ground		$V^+=15V$ , $T_a=25^\circ C$ (Note 2)		40	60	mA
Input Offset Voltage		(Note 5)			7	mV
Input Offset Voltage Drift		$R_s=0\Omega$		7		$\mu V/^\circ C$
Input Offset Current		$I_{IN(+)} - I_{IN(-)}$			100	nA
Input Offset Current Drift		$R_s=0\Omega$		10		$pA/^\circ C$
Input Bias Current		$I_{IN(+)}$ or $I_{IN(-)}$		40	300	nA
Input Common-Mode Voltage Range		$V^+=30V$ (Note 7)	0		$\frac{V^+}{2}$	V
Large Signal Voltage Gain		$V^+=15V$ , ( $V_o=1\sim 11V$ ), $R_L \geq 2k\Omega$	25			V/mV
Output Voltage Swing	$V_{OH}$	$V^+=30V$	$R_L=2k\Omega$	26		V
			$R_L=10k\Omega$	27	28	V
	$V_{OL}$	$V^+=5V$ , $R_L=10k\Omega$		5	20	mV
Output Current	Source	$V_{IN(+)}=1V$ , $V_{IN(-)}=0V$ , $V^+=15V$ , $V_o=2V$	10	20		mA
	Sink	$V_{IN(-)}=1V$ , $V_{IN(+)}=0V$ , $V^+=15V$ , $V_o=2V$	5	8		mA

---

**Note 1** The dissipation is the total of both amplifiers—use external resistors, where possible, to allow the amplifier to saturate or to reduce the power which is dissipated in the integrated circuit.

**Note 2:** Short circuits from the output to  $V^+$  can cause excessive heating and eventual destruction. When considering short circuits to ground, the maximum output current is approximately 40mA independent of the magnitude of  $V^+$ . At values of supply voltage in excess of +15V, continuous short-circuits can exceed the power dissipation ratings and cause eventual destruction. Destructive dissipation can result from simultaneous shorts on all amplifiers.

**Note 3:** This input current will only exist when the voltage at any of the input leads is driven negative. It is due to the collector-base junction of the input PNP transistors becoming forward biased and thereby acting as input diode clamps. In addition to this diode action, there is also lateral NPN parasitic transistor action on the IC chip. This transistor action can cause the output voltages of the op amps to go to the  $V^+$  voltage level (or to ground for a large overdrive) for the time duration that an input is driven negative. This is not destructive and normal output states will re-establish when the input voltage, which was negative, again returns to a value greater than -0.3V (at 25°C).

**Note 4:** With the D358, all temperature specifications are limited to  $-25^{\circ}\text{C} \leq T_a \leq 85^{\circ}\text{C}$ .

**Note 5:**  $V_o=1.4\text{V}$ ,  $R_s = 0\Omega$  with  $V^+$  from 5V to 30V; and over the full input common-mode range (0V to  $V^+ -1.5\text{V}$ ) at 25°C

**Note 6:** The direction of the input current is out of the IC due to the PNP input stage. This current is essentially constant, independent of the state of the output so no loading change exists on the input lines.

**Note 7:** The input common-mode voltage of either input signal voltage should not be allowed to go negative by more than 0.3V (at 25°C). The upper end of them common-mode voltage range is  $V^+ -1.5\text{V}$  (at 25°C), but either or both inputs can go to +32V without damage, independent of the magnitude of  $V^+$ .

**Note 8:** Due to proximity of external components, insure that coupling is not originating via stray capacitance between these external parts. This typically can be detected as this type of capacitance increases at higher frequencies.

---

# TYPICAL SINGLE-SUPPLY APPLICATION CIRCUIT

**Non-Inverting DC Gain (0V output)**

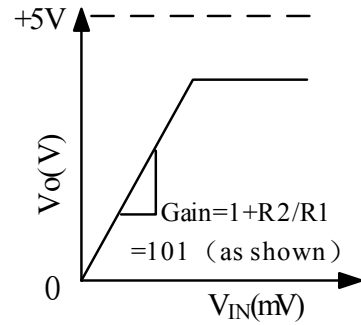
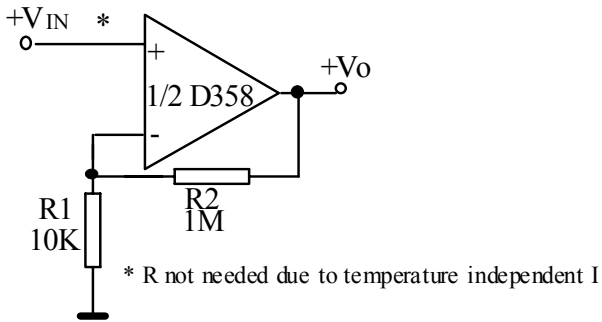

**DC Summing Amplifier**  
( $V_{NS} \geq 0V$ , and  $V_o \geq 0V$ )

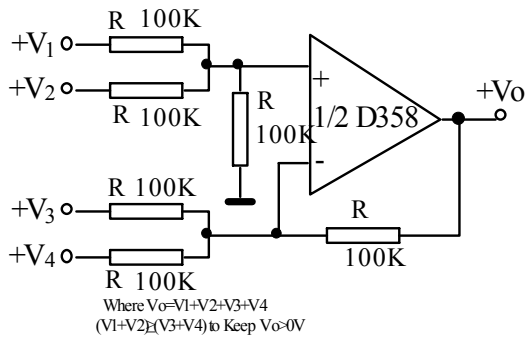

**Power Amplifier**

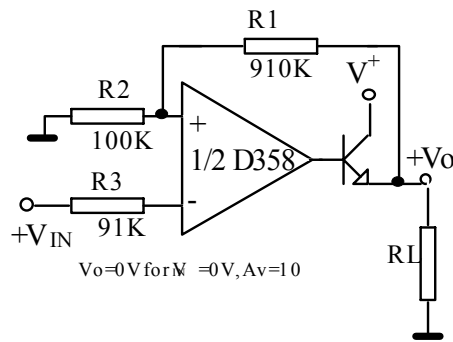

**"BI-QUAD" RC Active Bandpass Filter**

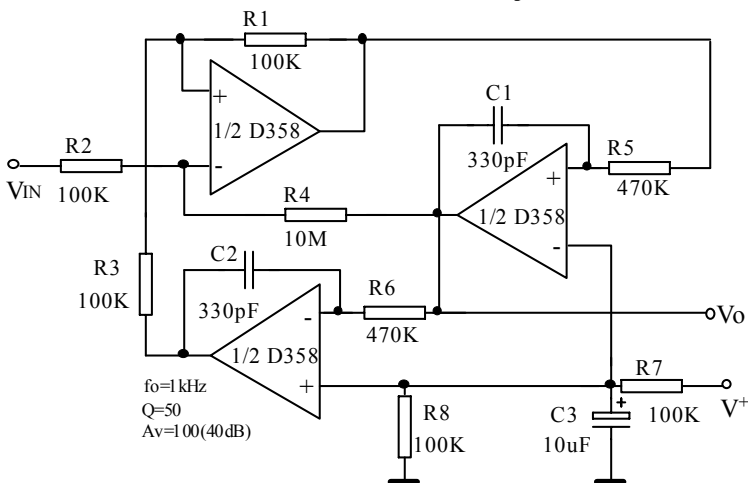

**Fixed Current Sources**

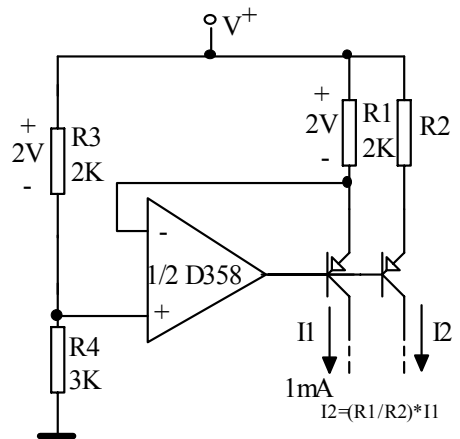

---

## APPLICATION HINTS

The LM358 is op amps which operate with only a single power supply voltage, have true-differential inputs, and remain in the linear mode with an input common-mode voltage of 0V. These amplifiers operate over a wide range of power supply voltage with little change in performance characteristics. At 25°C amplifier operation is possible down to a minimum supply voltage of 2.3 V.

Precautions should be taken to insure that the power supply for the integrated circuit never becomes reversed in polarity or that the unit is not inadvertently installed backwards in a test socket as an unlimited current surge through the resulting forward diode within the IC could cause fusing of the internal conductors and result in a destroyed unit.

Large differential input voltages can be easily accommodated and, as input differential voltage protection diodes are not needed, no large input currents result from large differential input voltages. The differential input voltage may be larger than  $V^+$  without damaging the device. Protection should be provided to prevent the input voltages from going negative more than -0.3V (at 25°C). An input clamp diode with a resistor to the IC input terminal can be used.

To reduce the power supply current drain, the amplifiers have a class A output stage for small signal levels which converts to class B in a large signal mode. This allows the amplifiers to both source and sink large output currents. Therefore both NPN and PNP external current boost transistors can be used to extend the power capability of the basic amplifiers. The output voltage needs to raise approximately 1 diode drop above ground to bias the on-chip vertical PNP transistor for output current sinking applications.

For ac applications, where the load is capacitively coupled to the output of the amplifier, a resistor should be used, from the output of the amplifier to ground to increase the class A bias current and prevent crossover distortion. Where the load is directly coupled, as in dc applications, there is no crossover distortion.

Capacitive loads which are applied directly to the output of the amplifier reduce the loop stability margin. Values of 50pF can be accommodated using the worst-case non-inverting unity gain connection. Large closed loop gains or resistive isolation should be used if larger load capacitance must be driven by the amplifier.

Output short circuits either to ground or to the positive power supply should be of short time duration. Units can be destroyed, not as a result of the short circuit current causing metal fusing, but rather due to the large increase in IC chip dissipation which will cause eventual failure due to excessive junction temperatures. Putting direct short-circuits on more than one amplifier at a time will increase the total IC power dissipation to destructive levels, if not properly protected with external dissipation limiting resistors in series with the output leads of the amplifiers. The larger value of output source current which is available at 25°C provides a larger output current capability at elevated temperatures (see typical performance characteristics) than a standard IC op amp.

---

# TYPICAL PERFORMANCE CHARACTERISTICS

**Input Voltage Range**

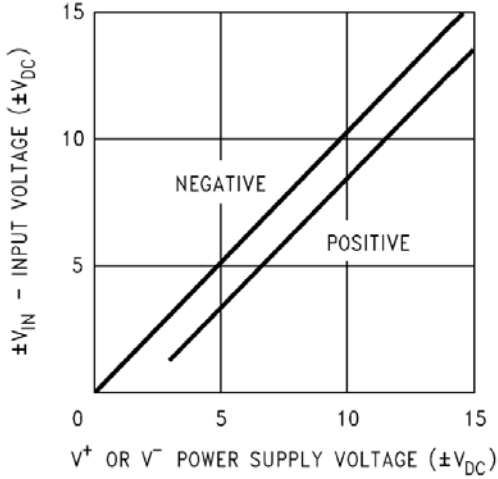

**Input Current**

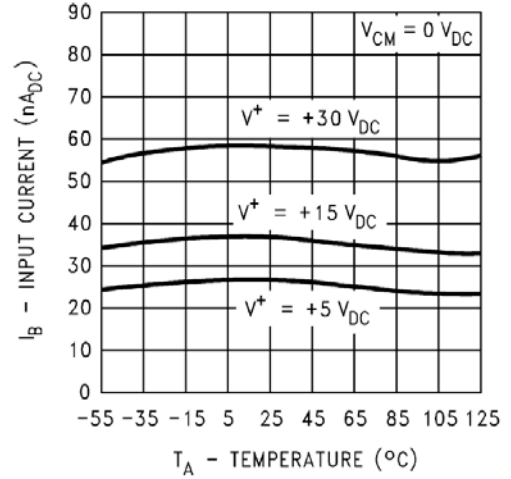

**Supply Current**

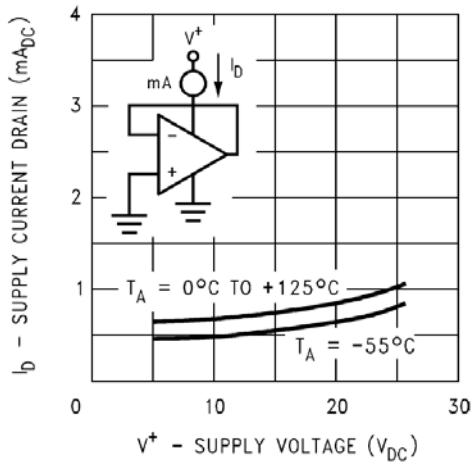

**Voltage Gain**

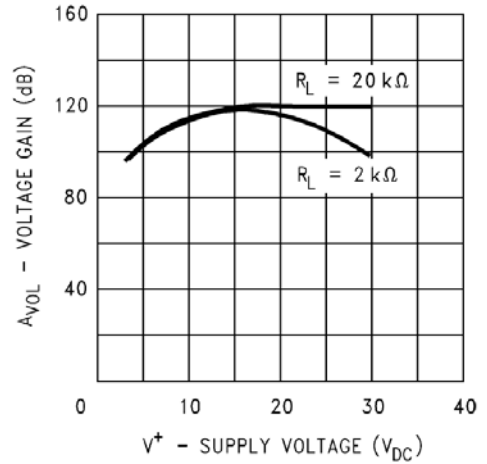

**Open Loop Frequency Response**

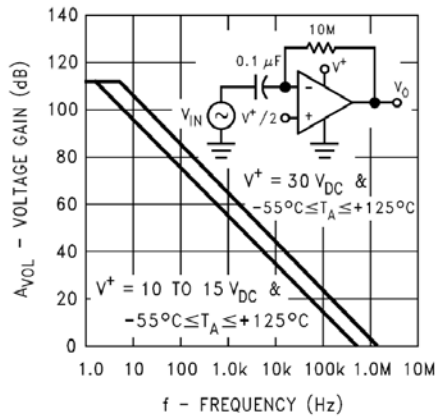

**Common-Mode Rejection Ratio**

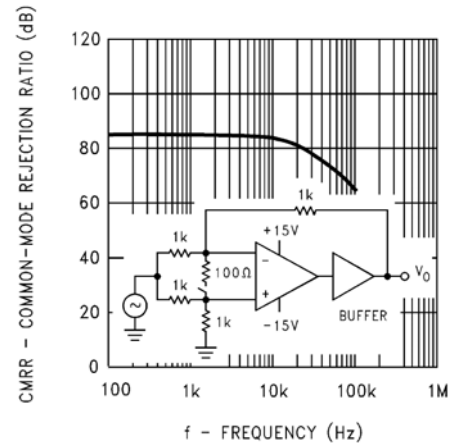

**Voltage Follower Pulse Response**

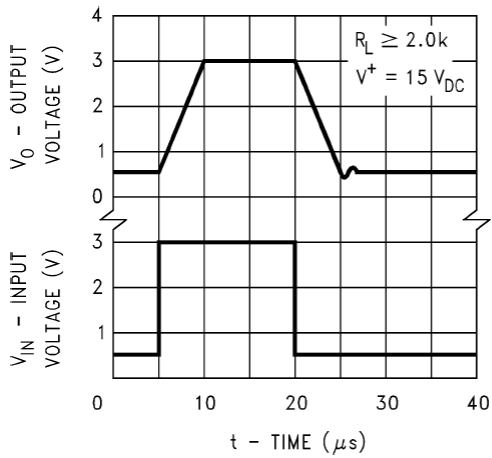

**Voltage Follower Pulse Response (Small Signal)**

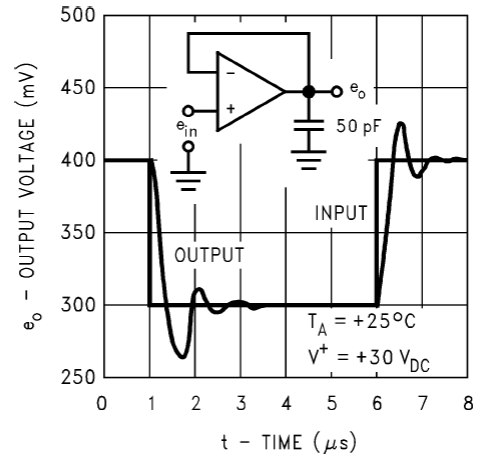

**Large Signal Frequency Response**

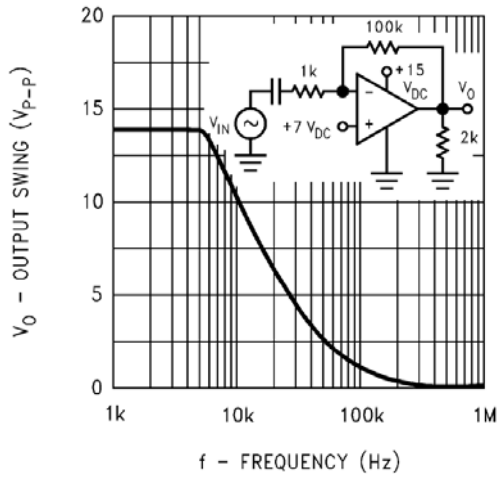

**Output Characteristics Current Sourcing**

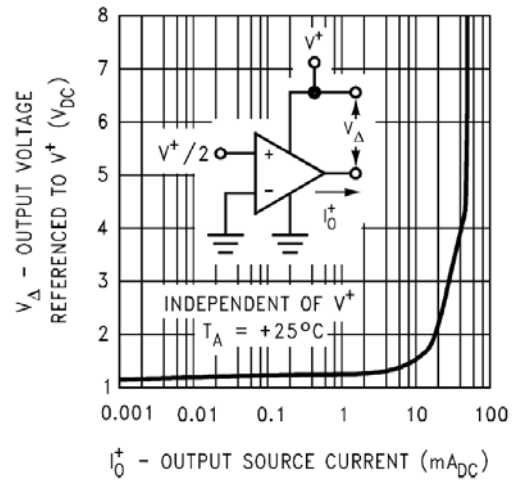

**Output Characteristics Current Sinking**

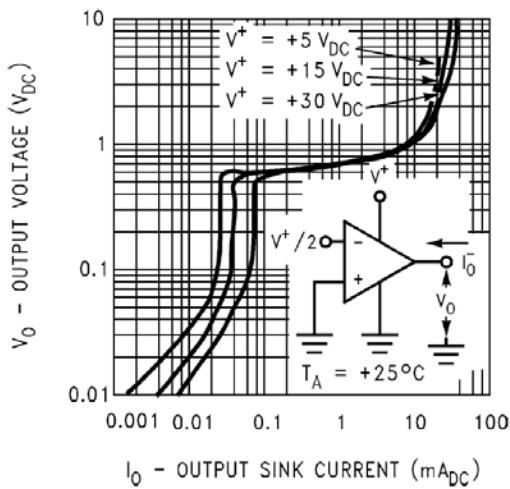

**Current Limiting**

