



Low Supply Voltage 75Ω Driver

MM1671

DESCRIPTIONS

This IC is a 75Ω driver with a built-in LPF that can operate at low voltage. It supports 3V and 5V operating power voltage, and is ideal for video signal output in devices ranging from portable digital still cameras to stationary equipment such as DVD players. It incorporates a high performance 4-stage LPF, which is ideal for removing DAC sampling noise. In addition, ultra-low current consumption has been achieved by suppressing current consumption during power save to under 1μA. This lengthens the life of the batteries in portable devices.

The built-in amp gain on this IC is 6dB and there is also with input clamp, allowing support for a range of video signals, not just composite signals.

FEATURES

- Operating power voltage 2.8~5.5V (supports 3V and 5V systems)
- Operating temperature range -40~85°C
- Current consumption (no signal) 7.0mA typ.
- Current consumption during power save 1.0μA max.
- High precision voltage gain 6±0.3dB at 100kHz
- Built-in high-performance 4-stage LPF 6.75MHz/100kHz max. ±1.0dB
27MHz/100kHz typ. -40dB
- Built-in sag auxiliary circuit
- Built-in 6dB amp output gain available
- available with input clamp
- Ultra-small package

BLOCK DIAGRAM

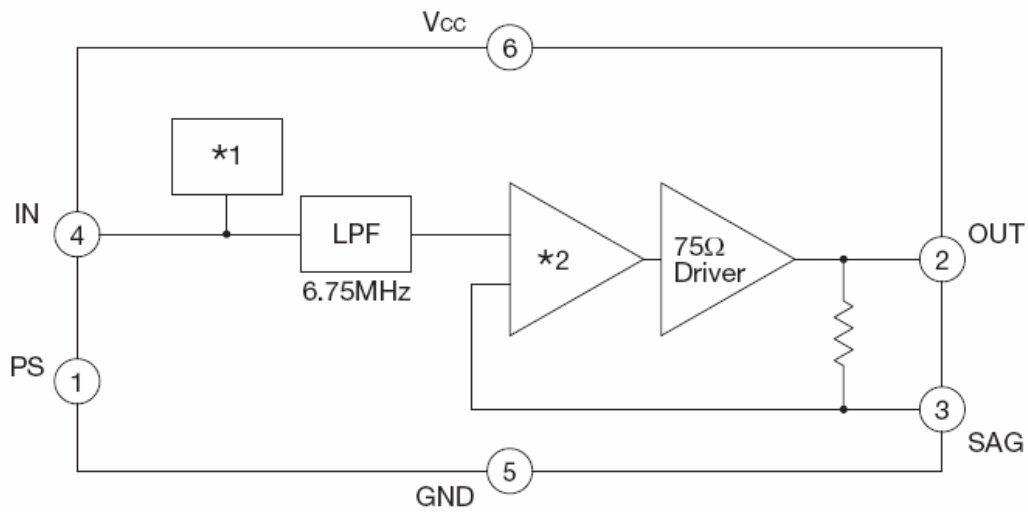

PIN ASSIGNMENT

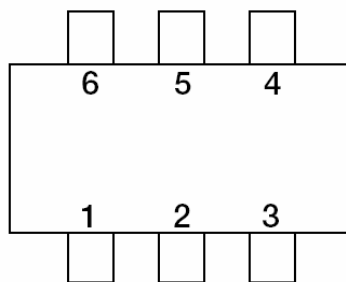

1	PS
2	OUT
3	SAG
4	IN
5	GND
6	Vcc

SOT23-6

MARKING INFORMATION

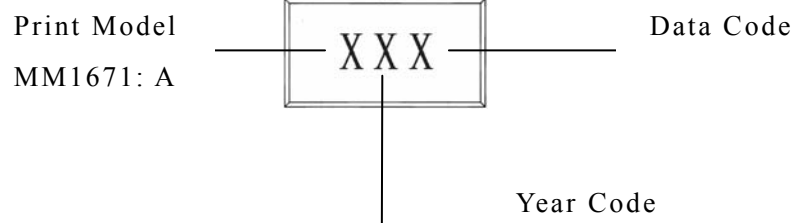

PIN DESCRIPTIONS

Pin no.	Pin name	Function	Internal equivalent circuit diagram
1	PS	Power save	
2	OUT	Signal output	
3	SAG	SAG correction	
4	IN	Signal input	
5	GND	GND	
6	Vcc	Vcc	

ABSOLUTE MAXIMUM RATINGS (Ta=25°C)

Characteristic	Symbol	Value	Unit
Supply Voltage	Vcc max.	7	V
Allowable Loss	Pd	200	mW
Operating Temperature	Topr	-40 ~ +85	°C
Storage Temperature	Tstg	-65 ~ +150	°C

RECOMMENDED OPERATING CONDITIONS

Characteristic	Symbol	Value	Unit
Operating Voltage	V _{ccop}	2.8~5.5	V
Operating Temperature	T _{opr}	-40~+85	°C

ELECTRICAL CHARACTERISTICS(unless otherwise specified: Ta=25°C, V_{CC} =3V)

Characteristics	Symbol	Test conditions	Min	Typ	Max	Unit
Supply current	I _{cc1}	No signal		7	10	mA
Supply current (at power save mode)	I _{cc2}	No signal, PS: ON			1	μA
Power save terminal input current	H	I _{PSH}	1pin V _H =2.8V		360	μA
	L	I _{PSL}	1pin V _L =0.2V		18	μA
Power save terminal input voltage	H	V _{PSH}		2.0	V _{cc}	V
	L	V _{PSL}			0.5	V
Input terminal voltage	V _{IN}	4pin		1.2		V
Output terminal voltage	V _{OUT}	2pin	0.15	0.3	0.45	V
Voltage gain	G _v	SIN wave: 1V f=100kHz	5.7	6.0	6.3	dB
Frequency characteristics 1	fc1	SIN wave: 1V 6.75MHz/100kHz	-1.0	0	+1.0	dB
Frequency characteristics 2	fc2	SIN wave: 1V 27MHz/100kHz		-40	-27	dB
Differential gain	DG	Staircase signal 1V		0.7	1.5	%
Differential phase	DP	Staircase signal 1V		0.7	1.5	%
Output dynamic range	DR	SIN wave: 100kHz THD=1.0%	2.2	2.4		V
S/N	SN	BW: 100k~6MHz		74		dB
Group delay	t _l	At 100kHz		50	80	ns
Group delay	Δt _l	To 3.58MHz		4	10	ns
		To 4.43MHz		6	10	
		To 6MHz		12	20	

SWITCH CONTROL TABLE

PS-Pin	Power Save
H	OFF
L	ON
OPEN	ON

TEST CIRCUIT

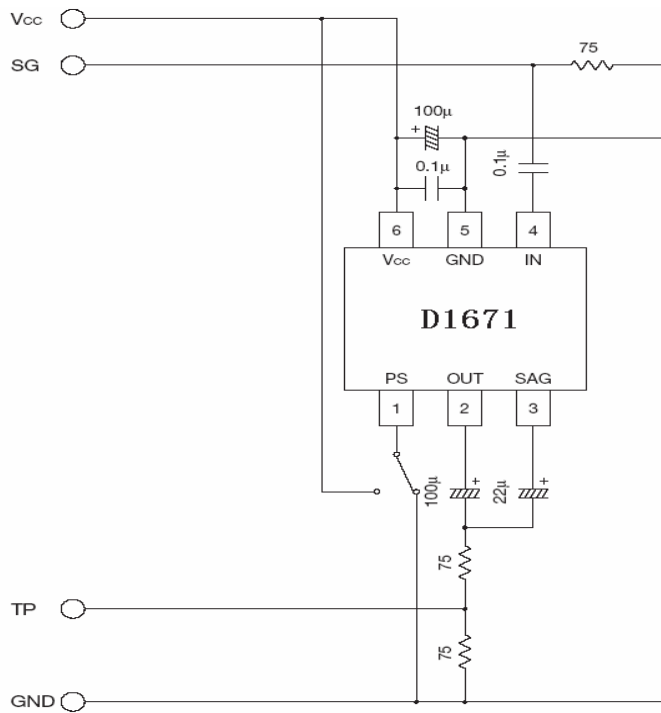

APPLICATION CIRCUIT

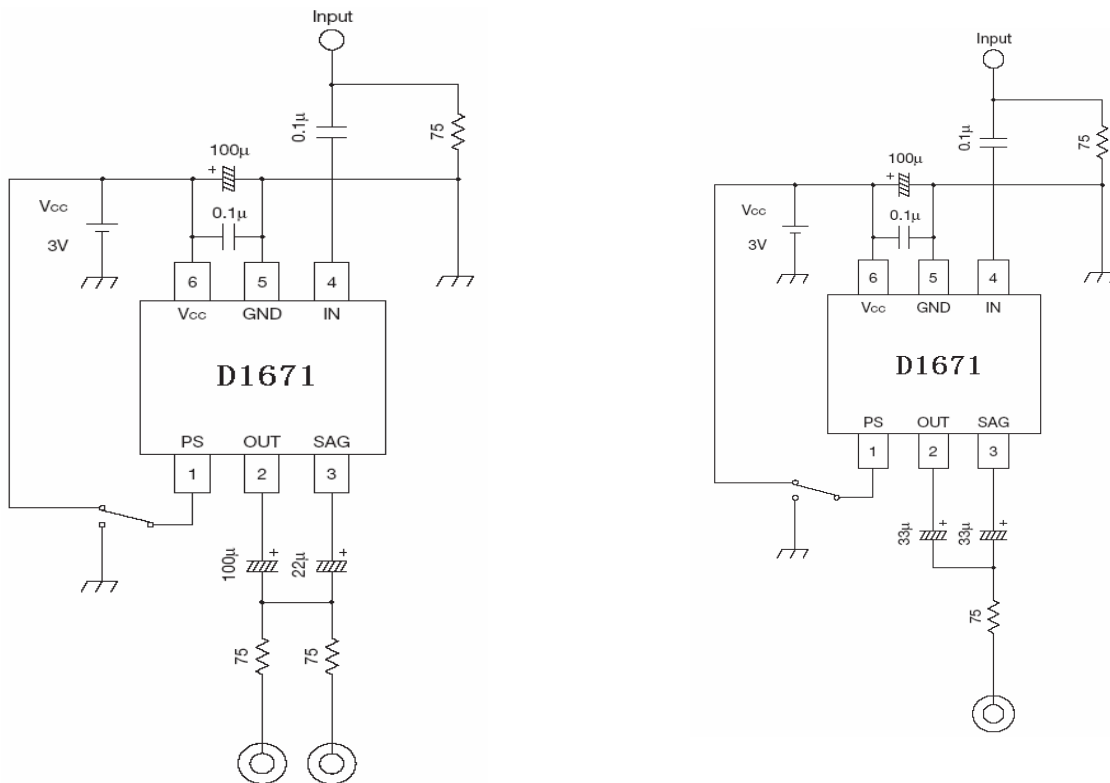

TYPICAL CHARACTERISTICS

unless otherwise specified: $T_a=25^{\circ}\text{C}$, $V_{CC}=3\text{V}$

Frequency Characteristic [log]

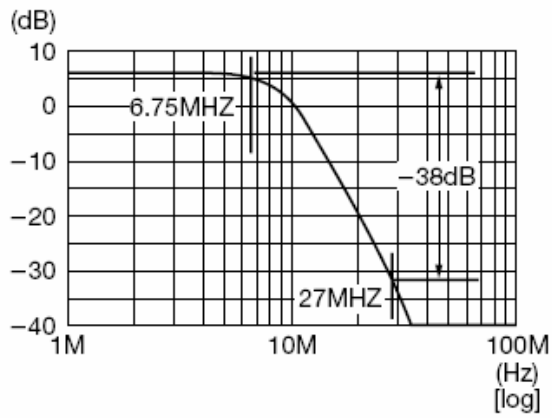

Frequency Characteristic [lin]

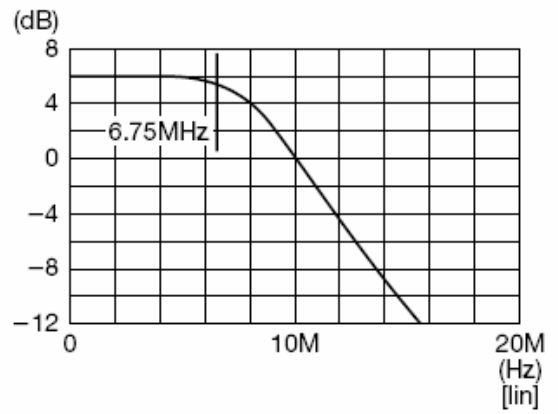

Group Delay [lin]

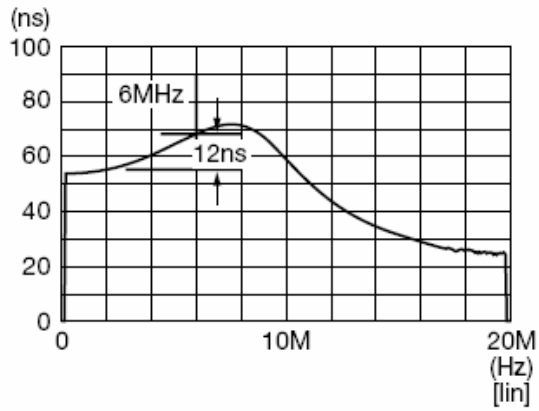

unless otherwise specified: $T_a=25^{\circ}\text{C}$, $V_{CC}=2.6\sim 6.0\text{V}$

Supply Current vs Supply Voltage

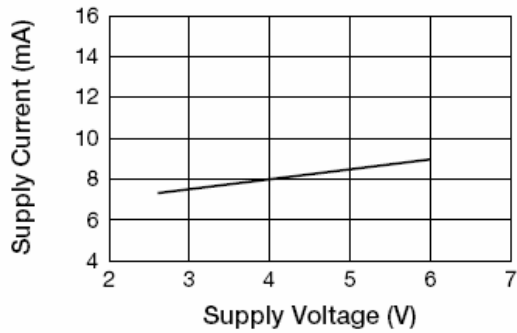

Supply Current vs Supply Voltage (at power save mode)

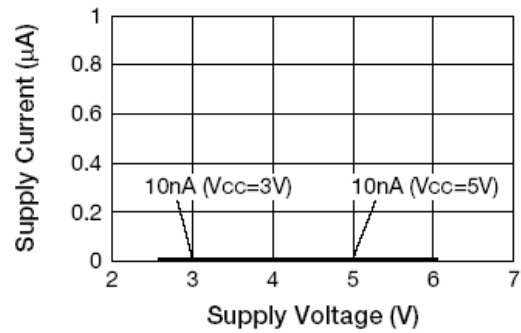

Input Terminal Voltage vs Supply Voltage

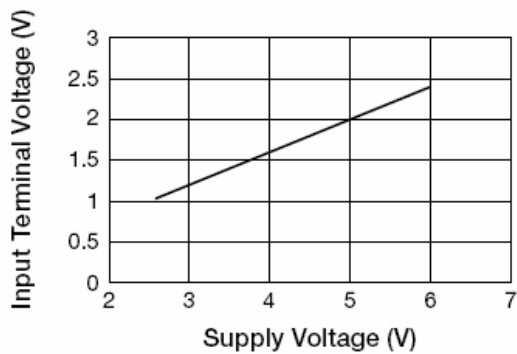

Output Terminal Voltage vs Supply Voltage

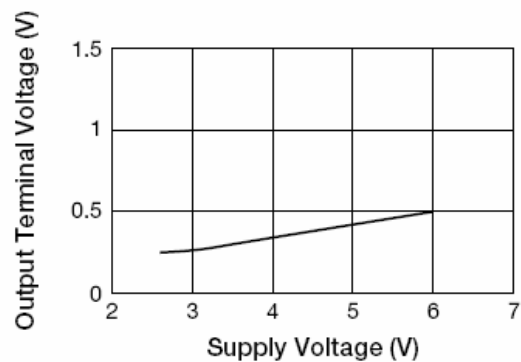

Differential Gain vs Supply Voltage

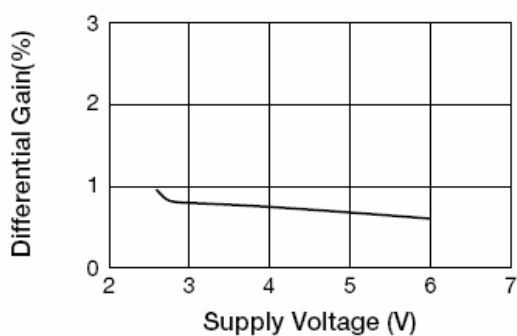

Differential Phase vs Supply Voltage

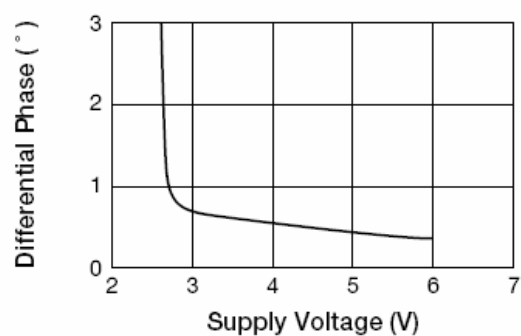

Output Dynamic Range vs Supply Voltage

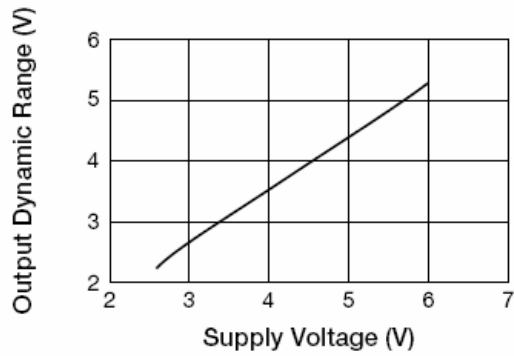

S/N vs Supply Voltage

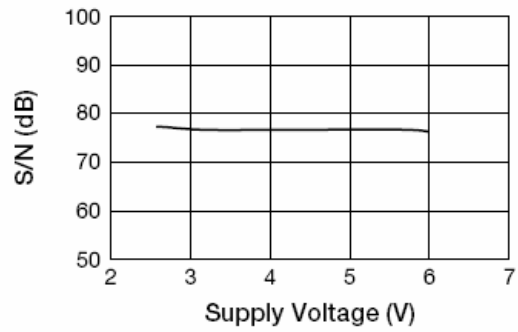

Voltage Gain vs Supply Voltage (f=100kHz)

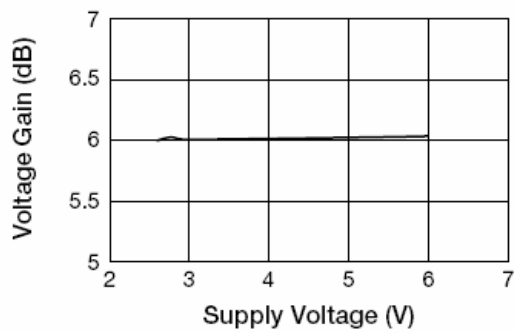

Frequency Characteristic 1 vs Supply Voltage (f=6.75MHz/100kHz)

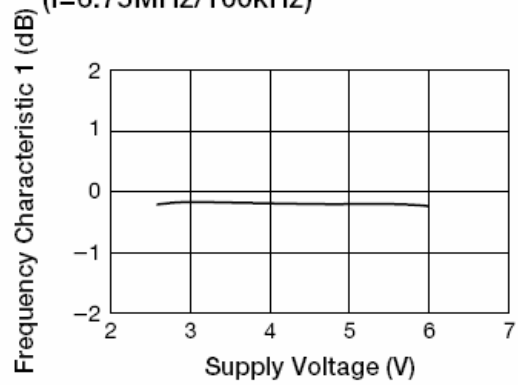

Frequency Characteristic 2 vs Supply Voltage (f=27MHz/100kHz)

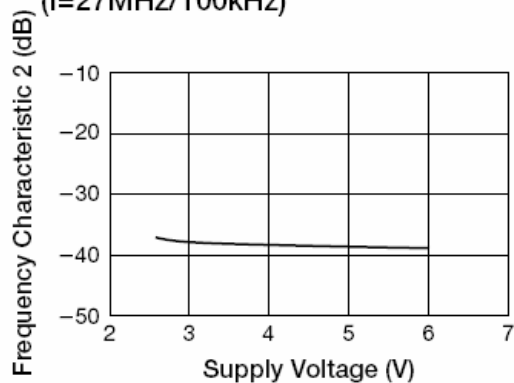

unless otherwise specified: $T_a = -50 \sim +90^\circ\text{C}$, $V_{CC} = 3\text{V}$

Supply Current vs Temperature

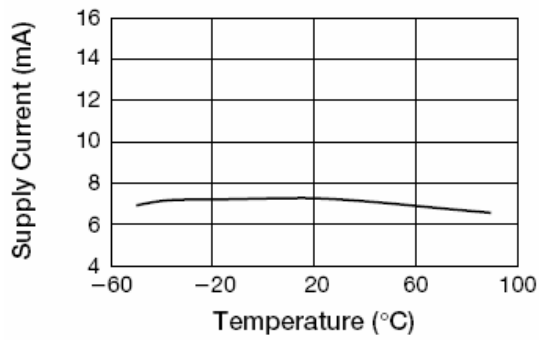

Supply Current vs Temperature (at power save mode)

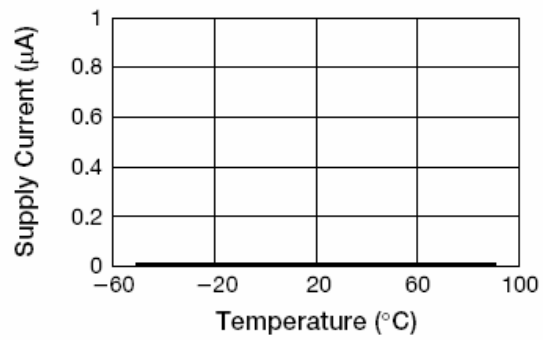

Input Terminal Voltage vs Temperature

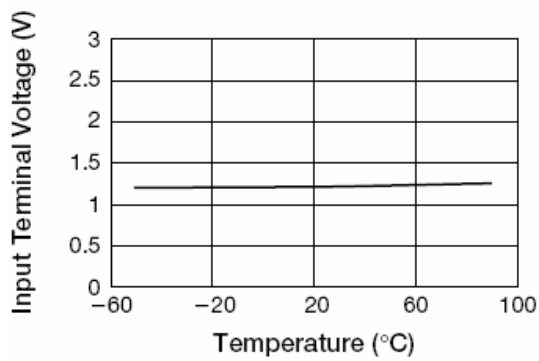

Output Terminal Voltage vs Temperature

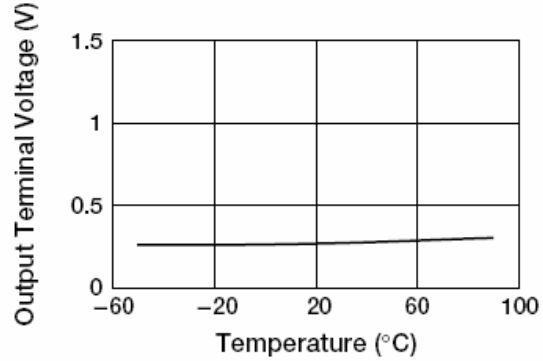

Differential Gain vs Temperature

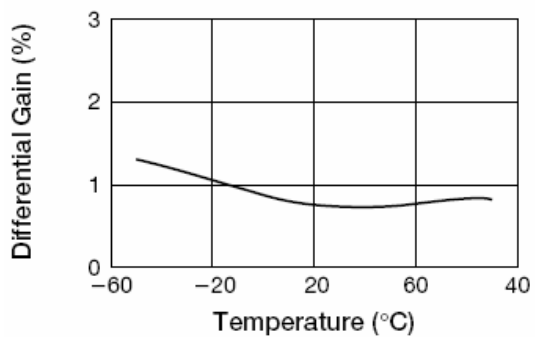

Differential Phase vs Temperature

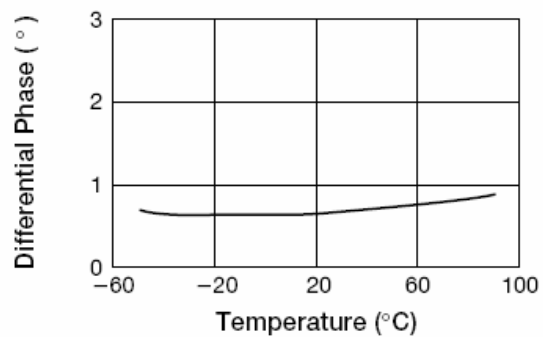

Output Dynamic Range vs Temperature

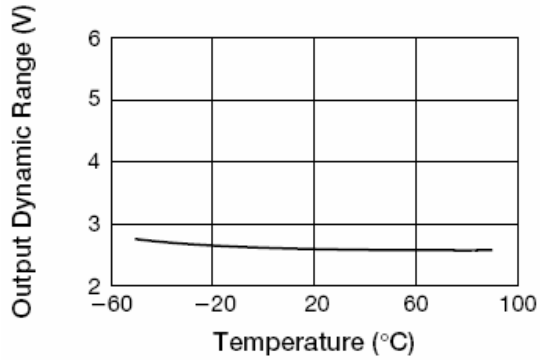

S/N vs Temperature

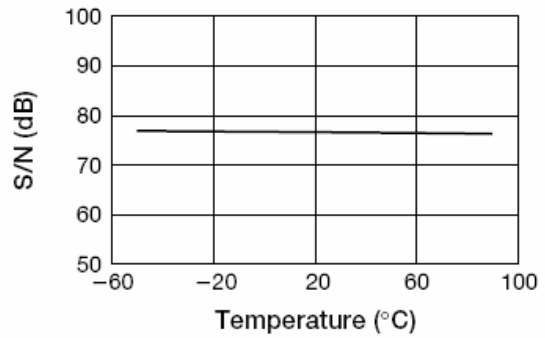

Voltage Gain vs Temperature (f=100kHz)

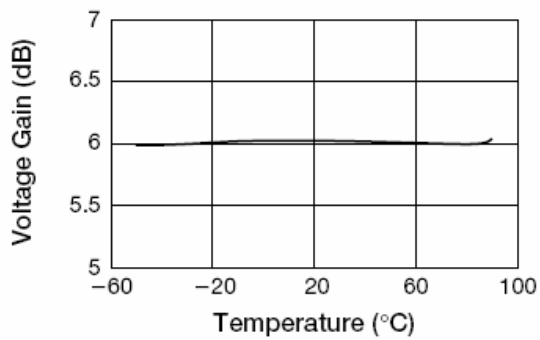

Frequency Characteristic 1 vs Temperature (f=6.75MHz/100kHz)

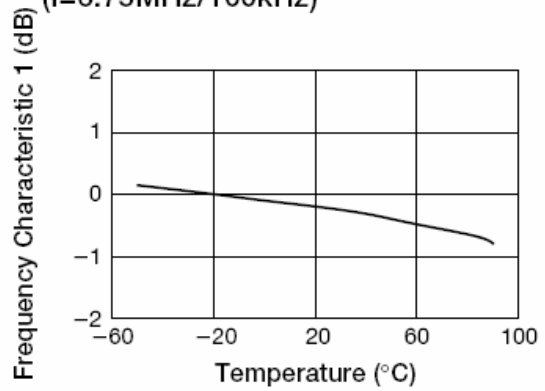

Frequency Characteristic 2 vs Temperature (f=27MHz/100kHz)

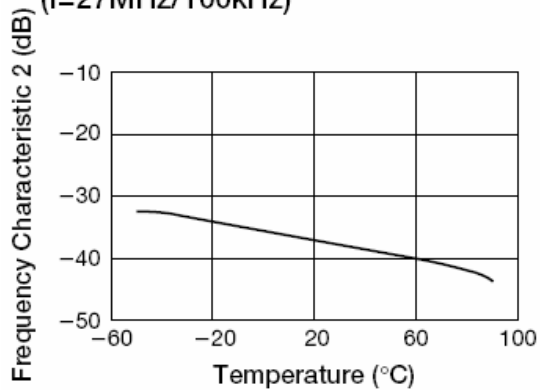

OUTLINE DRAWING

