



QUAD OPERATIONAL AMPLIFIER

LM2902

DESCRIPTION

The LM2902 consist of four independent, high gain, internally frequency compensated operational amplifiers which were designed specifically to operate from a single power supply over a wide voltage range. Operation from split power supplies is also possible and the low power supply current drain is independent of the magnitude of the power supply voltage. Application areas include transducer amplifier, DC gain blocks and all the conventional OP amp circuits which now can be easily implemented in single power supply systems.

FEATURE

- Large DC voltage gain: 100dB
- Wide power supply range:
 $V_{cc}=3V\sim 32V$ (or $V_{cc}=\pm 1.5V\sim \pm 16V$)
- Input common-mode voltage range includes ground.
- Large output voltage swing : $0V\sim V_{cc}-1.5V$
- Power drain suitable for battery operation
- Internally frequency compensated for unity gain
- Wide bandwidth(unity gain) 1MHz
- Very low supply current drain($700\mu A$)—essentially independent of supply voltage
- Low input biasing current 45nA
- Low input offset voltage 2mV and offset current 5nA
- Differential input voltage range equal to the power supply voltage
- Compatible with all forms of logic

Outline Drawing

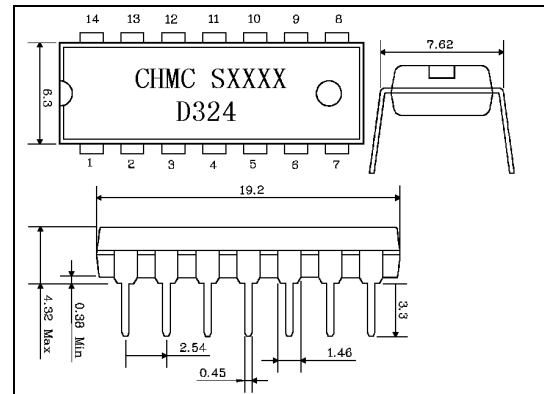

DIP14

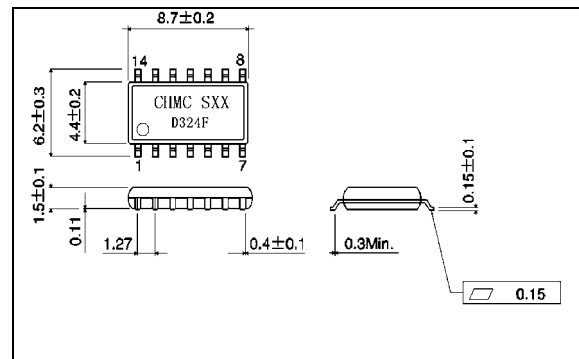

SOP14

SCHEMATIC DIAGRAM

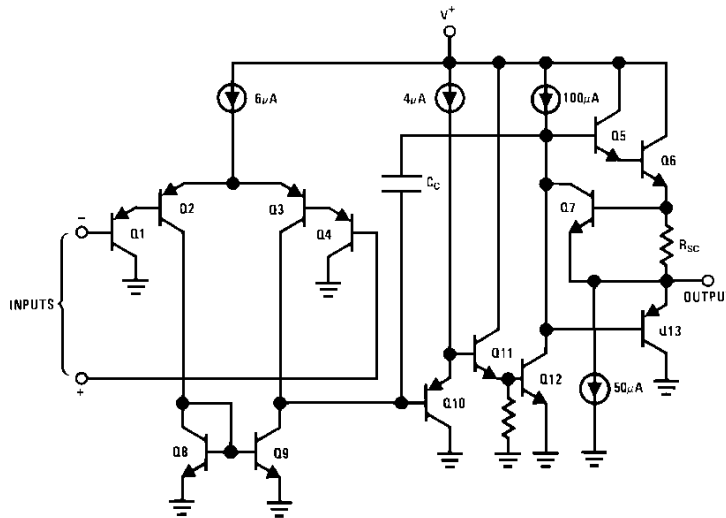

INTERNAL BLOCK DIAGRAM AND PIN CONNECTION

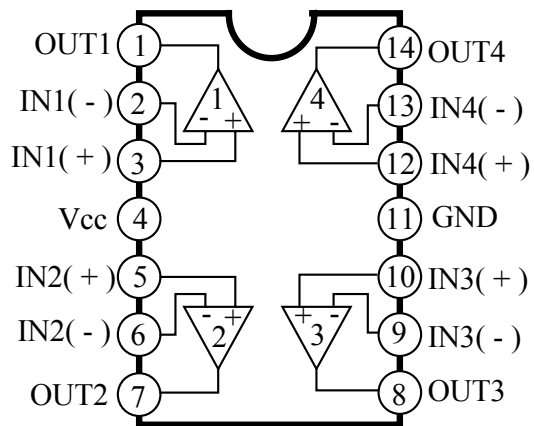

ABSOLUTE MAXIMUM RATINGS (Ta=25°C)

Characteristic		Symbol	Value	Unit
Power Supply Voltage		V _{cc}	±16 or 32	V
Differential Input Voltage		V _{ID}	32	V
Input Voltage		V _{IN}	-0.3~32	V
Output Short Circuit to GND			Continuous	
Power Dissipation	DIP14	P _D	1130	mW
	SOP14		800	
Operating Temperature Range		T _{opr}	-20~+85	°C
Storage Temperature		T _{stg}	-65~150	°C

ELECTRICAL CHARACTERISTICS

(unless otherwise specified: $T_a=25^{\circ}\text{C}$, $V_{cc}=5\text{V}$)

Characteristics		Test Conditions	Min.	Typ.	Max.	Unit
Input offset voltage				2	7	mV
Input bias current		$I_{IN(+)}$ or I_{IN-} , $V_{CM}=0\text{V}$		20	250	nA
Input offset current		$I_{IN(+)}$ or I_{IN-} , $V_{CM}=0\text{V}$		5	50	nA
Input common-mode voltage range		$V_{cc}=30\text{V}$	0		$V_{cc}-1.5$	V
Supply current		Over full temperature range $R_L=\infty$ on all OP amps $V_{cc}=30\text{V}$ $V_{cc}=5\text{V}$		1.5 0.7	3 1.2	mA
Large signal voltage gain		$V_{cc}=15\text{V}$, $R_L \geq 2\text{k}\Omega$	25	100		V/mV
Common-mode rejection ratio		DC, $V_{CM}=0\text{V}$ to $V_{cc}-1.5\text{V}$	65	85		dB
Power supply rejection ratio		$V_{cc}=5\text{V}$ to 30V	65	100		dB
Output current	Source	$V_{IN}^+=1\text{V}$, $V_{IN}^-=0\text{V}$ $V_{cc}=15\text{V}$, $V_o=2\text{V}$	20	40		mA
	Sink	$V_{IN}^+=0\text{V}$, $V_{IN}^-=1\text{V}$ $V_{cc}=15\text{V}$, $V_o=2\text{V}$	8	20		mA
		$V_{IN}^+=0\text{V}$, $V_{IN}^-=1\text{V}$ $V_{cc}=15\text{V}$, $V_o=200\text{mV}$	12	50		μA
Short circuit to ground		$V_{cc}=15\text{V}$		40	60	mA
Output voltage swing	V_{OH}	$V_{cc}=30\text{V}$, $R_L=2\text{k}\Omega$	26			V
		$V_{cc}=30\text{V}$, $R_L=10\text{k}\Omega$	27	28		V
	V_{OL}	$V_{cc}=5\text{V}$, $R_L=10\text{k}\Omega$		5	20	mV

CHARACTERISTICS CURVES

Input Voltage Range

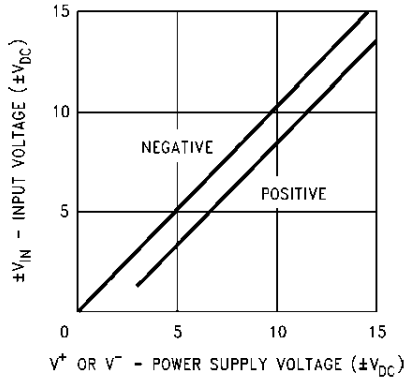

Input Current

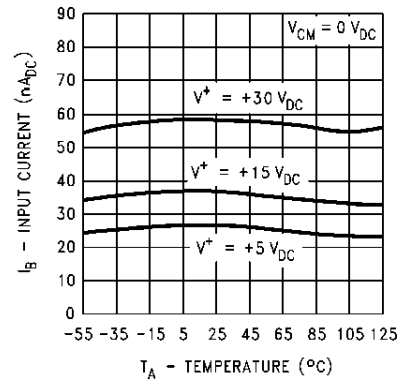

Voltage Gain

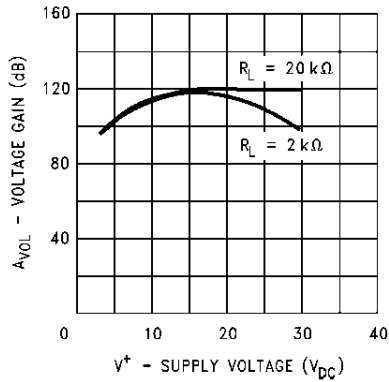

Open Loop Frequency Response

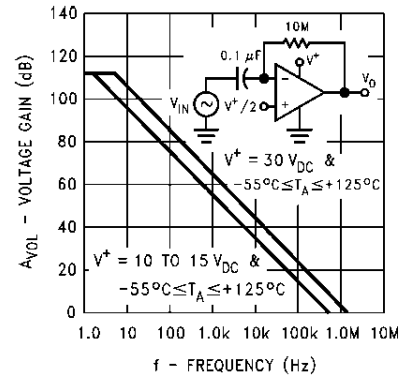

Supply Current

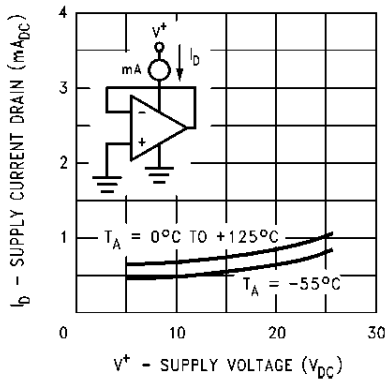

Common Mode Rejection Ratio

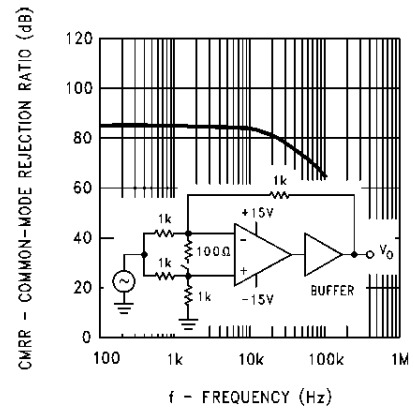

Voltage Follower Pulse Response

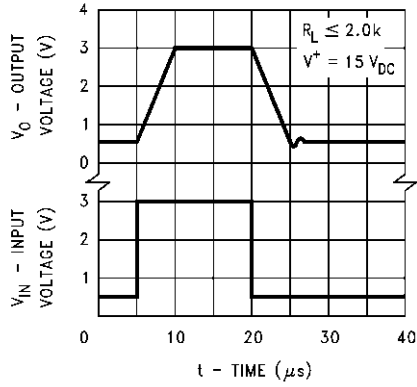

Voltage Follower Pulse Response (Small Signal)

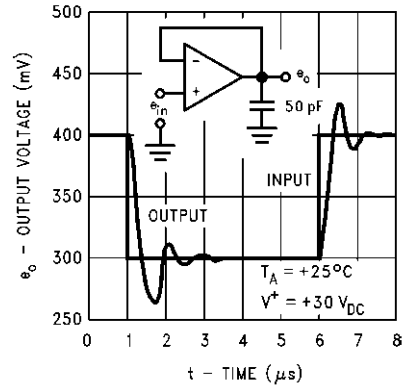

Output Characteristics Current Sourcing

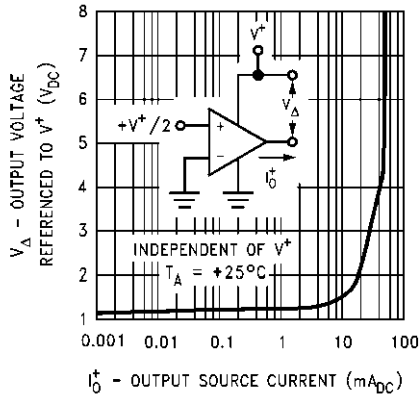

Output Characteristics Current Sinking

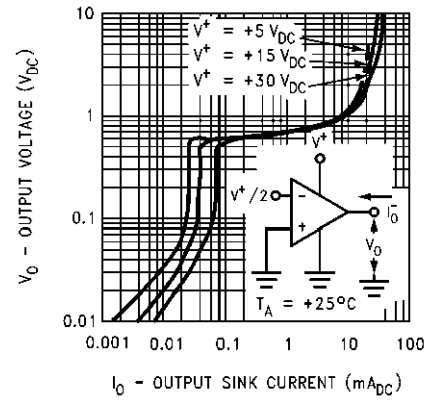

Large Signal Frequency Response

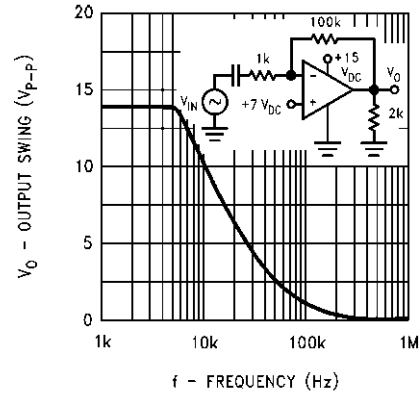

Current Limiting

